

热释电人体红外传感器

型号: XKC-003K4

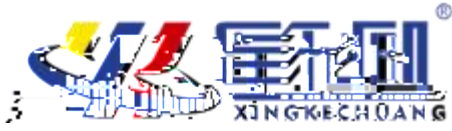







XKC-003K4

1. : ,
2. (U# +,): ,
- 3.

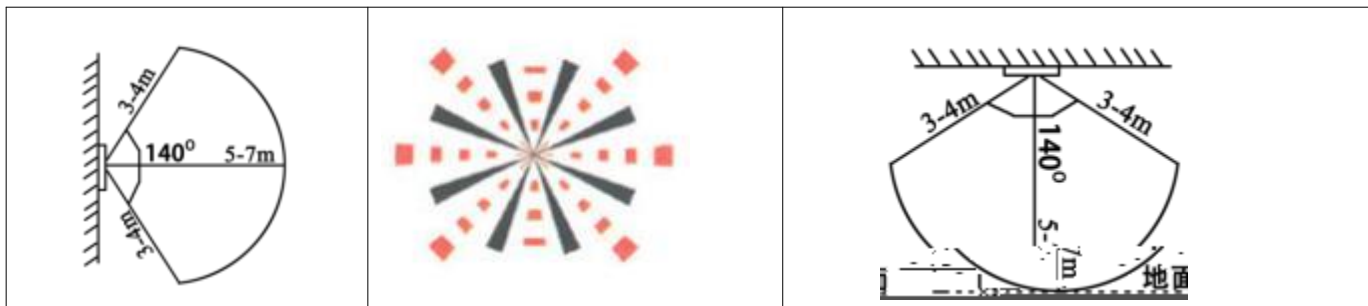
	DC5-12V
	< 200uA
	(3.3V/ 0V) /NPN/ (/) / 2A LED
	L /H ()
	5S (5-300S)
	1S
	32mm*24mm
	52L*36W*23H mm (), Φ2.5
	28 cm
	<110
	7
	-20~85
	:23mm ()

序号	型号	输出信号
1	XKC-003K4-V	(3.3V/ 0V) < 3mA
2	XKC-003K4-N	NPN () < 300mA
3	XKC-003K4-M	() 3A
4	XKC-003K4-MC	() 3A
5	XKC-003K4-LED 2A	LED 2A

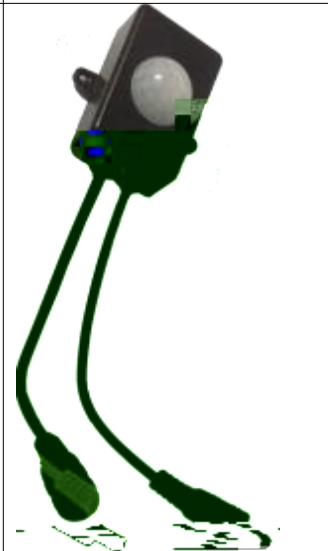

<p>XKC-003K4-V XKC-003K4-N</p>	<p>XKC-003K4-M XKC-003K4-MC</p>	<p>XKC-003K4-LED 2A</p>	
			

1. : 51.5mm(L)*52.6mm(W)*32.5mm(H) (003K4-V/N/PN/M/MC)

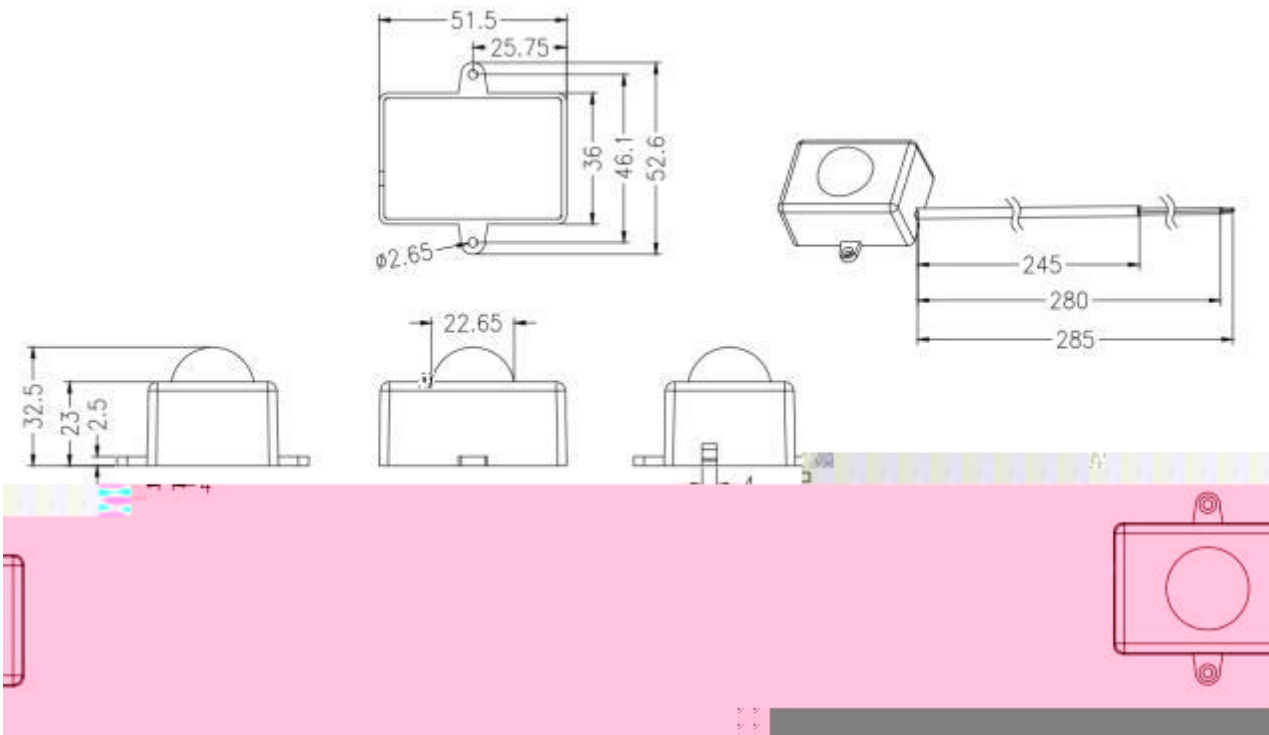

2. XKC-003K4-LED 2A

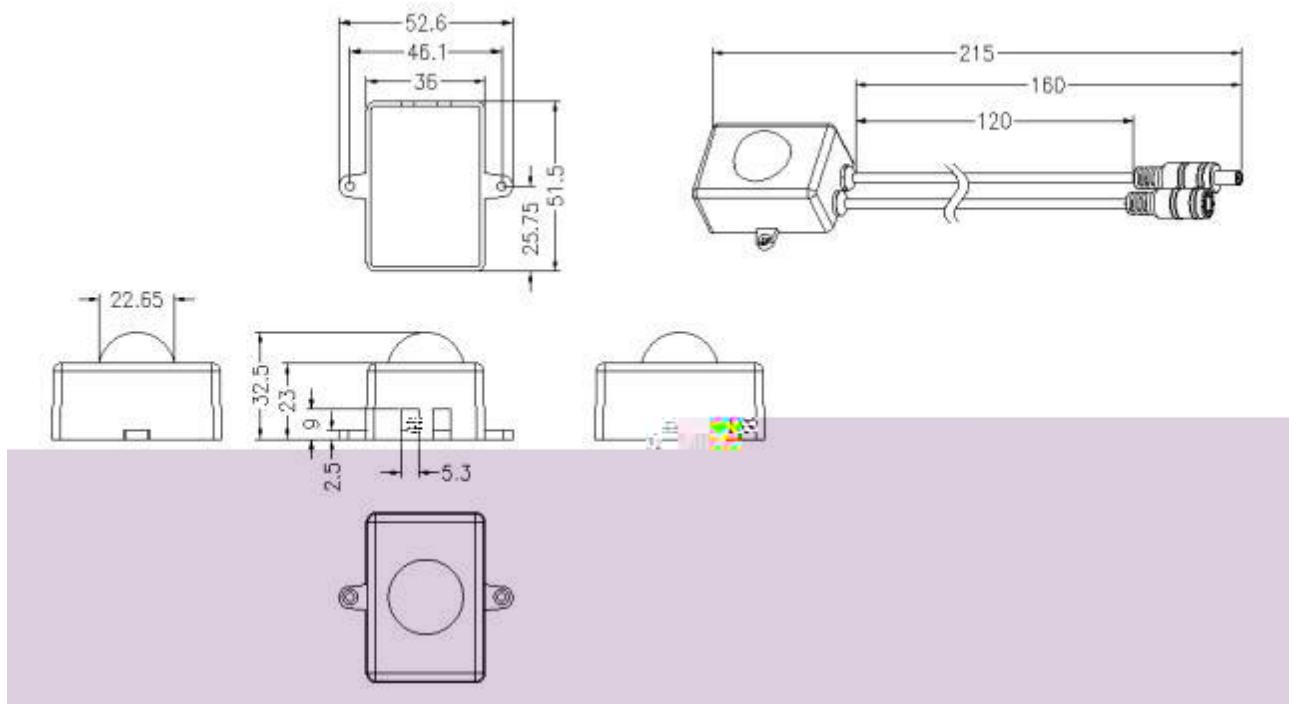

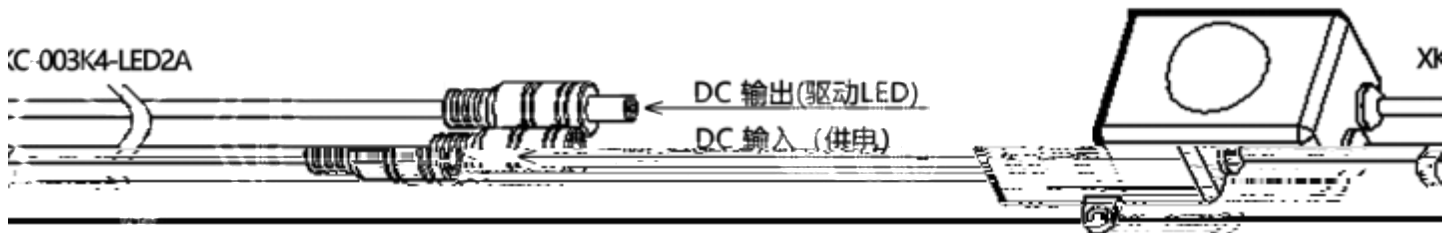
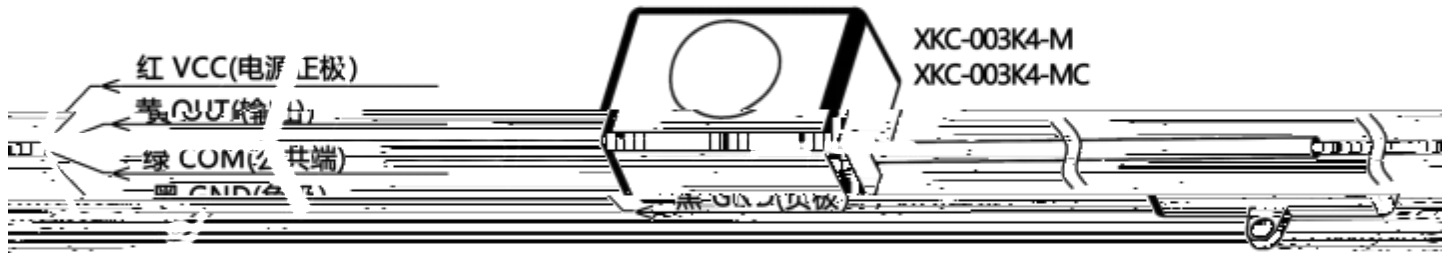
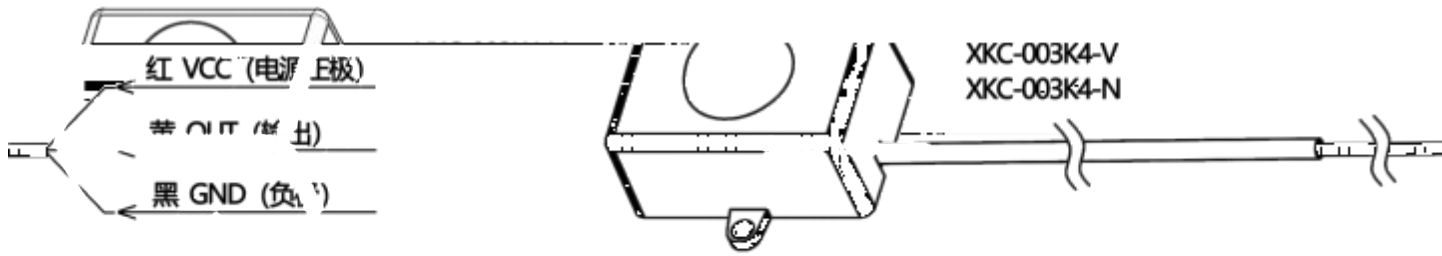

(3); (7);
(5S); (300S);

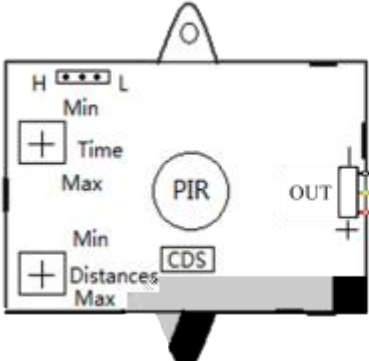
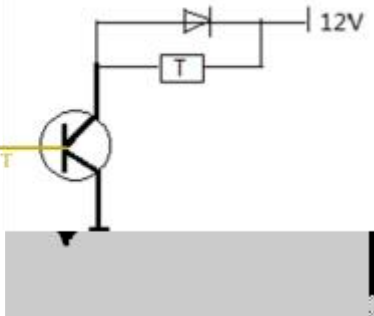
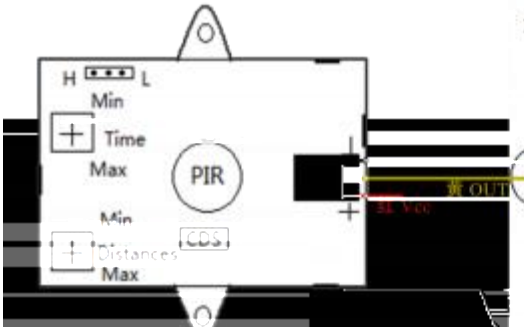
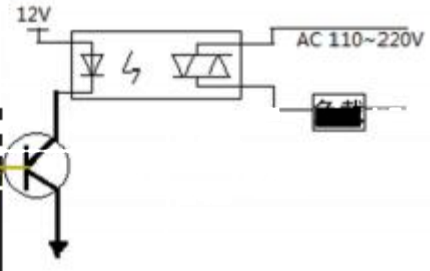
1.		1. ; 2.OUT ; 3. ; 4.L ; H ; 5.CDS ; 6.Time ; 7.Distances
2.		
3.		

()

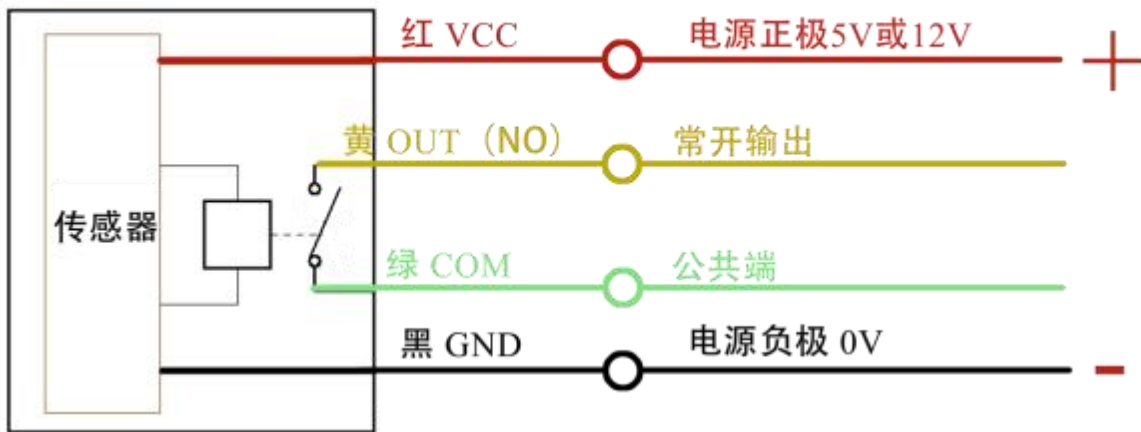

()



1. , 0-3 ,
2. ;
3. ,
4. (30~32),

()

1. ;

2. (DOA) 7

DOA ;

();

()

1. /

/

2.

3.

()

()

()